

A close-up, low-angle photograph of a heavy-duty tracked vehicle's tread pattern. The treads are dark, rectangular blocks arranged in a staggered grid, receding into the distance. The background is a blurred, dark grey, suggesting an industrial or construction environment. A bright yellow horizontal bar is at the top of the page.

AKTV8

PressureTech™ Installation Guide

TABLE OF CONTENTS

1 Introduction	1
2 PressureTech™ App – Download and Configuration	1
3 PressureTech™ TPMS	6
4 PressureTech™ Load	
a. Onboard Scale Sensor(s) Installation	8
b. Cutting Air Hose	12
c. Leak Checking	13
5 Gateway Range Extender Installation	15
6 FAQ	
a. TPMS	19
b. Onboard Scales	21
7 Troubleshooting	
a. TPMS	22
b. Onboard Scales	27
8 Battery Replacement	29

1 | Introduction

AKTV8's journey began by developing integrated control systems for air suspensions and pneumatic systems across all transportation markets. That experience has led to our latest product, PressureTech™, which is a configurable pressure-monitoring sensor platform capable of keeping tabs on tire pressure, suspension pressure, onboard scales and virtually any other pneumatic system on a vehicle.

PressureTech™ products are designed and tested to automotive and heavy-truck OEM standards that, depending on the application, will last two years or more on a single, replaceable battery. Each sensor is easily configured by scanning a durable, laser-etched QR code on the cap.

PressureTech™ can be used as a stand-alone system with the mobile app or in combination with the AKTV8 iAir® gateway range extender to enhance functionality. Each Sensor Kit comes equipped with everything needed to complete installation. Unlike hobby-grade systems, PressureTech was designed to withstand the rigors of heavy trucks. It offers a single mobile app for TPMS, load monitoring and gateway range-extender configuration. PressureTech is the all-in-one solution that makes managing one or all applications easy.

The following installation instructions may vary based on the year, make, model and configuration of the vehicle(s).

2 | PressureTech™ App – Download App and Setup Vehicle

STEP ONE: DOWNLOAD AND INSTALL APP

Download and install the AKTV8 PressureTech™ app from the Google Play Store for Android devices or the Apple App Store for Apple devices.

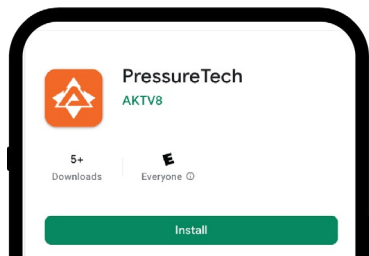

- Allow the AKTV8 PressureTech™ app access to your device's location if prompted (you will only be asked this the first time the app is opened).
- Allow the AKTV8 PressureTech™ app to turn on Bluetooth on your device if prompted — if Bluetooth is off, you will be asked to turn it on each time the app is opened.

After opening the PressureTech™ app, you will be taken to the "Drive Mode" page. This page allows you to view vehicles and configure app settings.

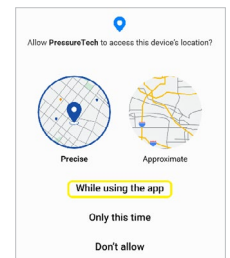
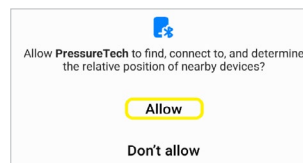

2 | STEP TWO: APP SETTINGS

- On the top-right corner, tap the list drop down.
- Select " App Settings."
- Tap "Prevent Screen Lock" if desired.
- Tap "Enable Alerts" if desired.

Advanced Settings

The PressureTech™ app offers two options for delivering email alerts:

Drive Mode: emails can be accessed from the Drive Mode page. If there is a change in tire pressure, temperature, battery life or vehicle weight, the user can manually share the vehicle's status.

Critical Alerts: allows user to set up notifications for gross weight and axle weight. When the weight limit is reached, an alert is automatically sent to the designated recipients.

- Configure Drive Mode email alerts if desired:
 - » Tap "Tap "Drive Mode Status."
 - » Add your email address and tap "Save."
- Configure Critical email alerts if desired:
 - » Tap "Critical Alerts."
 - » Set the email delay for sending Critical email alerts.
 - » Set the overweight threshold.
 - » Use toggle switch to enable or disable Critical email alerts.
- "Enable Scan" turns on continuous scanning when the app is open to improve sensor read time.

Note: This consumes battery life, so make sure phone is charging.

 - » Select the type of units desired.
 - » Tap "Show Frost Law*" if desired.
 - » Reset app option will remove all settings and vehicles.

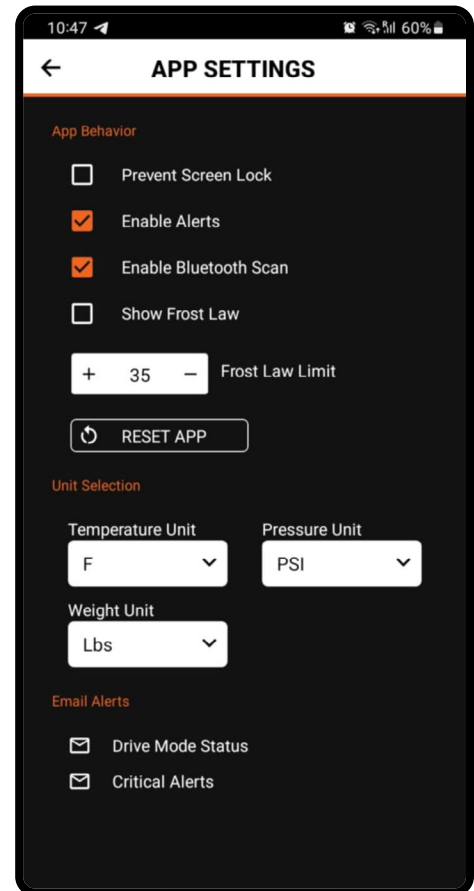

* Frost Laws are seasonal weight restrictions imposed on certain roads during periods of thawing, typically in late winter and early spring. These restrictions help protect roads from damage caused by heavy vehicles when the ground beneath the pavement is weakened by melting frost. Weight limits may vary by region and road type, and enforcement periods depend on weather conditions. Drivers should check local regulations to ensure compliance.

2 | STEP THREE: CREATE VEHICLE

Creating a Vehicle is required before pairing and installing the AKTV8 sensors. Once created, vehicles can be easily added or removed, giving you the ability to easily swap vehicles for viewing.

- On the left corner click the hamburger menu and on the bottom of "My Vehicles" screen, tap "Add Vehicles."
- Fill in all required fields.
- Select vehicle configuration and select the type of vehicle to configure.
- Select type of product: TPMS sensor and/or Onboard Scale sensor.
- If installing on truck or car, check "Enable Steer Axle."
- "Select Number of Rear Axles": not including steer axle.
- "Select Tires per Axle": single tire or dual tires.
- Tap "Save" to add the configuration to the app's Vehicle page.

ADD VEHICLE

11:10 58%

← **ADD CONFIGURATIONS**

Vehicle Data

Vehicle Name

License

Picture

Product Configuration

Vehicle Configuration

Select

Select Products

Number of rear axles

2

Tires per axle

Select

Steer axle

Select

Low PSI

High PSI

SAVE

Select

Semi-Truck

Semi-Trailer

Pickup Truck

Trailer

Car

Motorcycle

Custom

Select Products

TPMS Sensors

Onboard Scale Load Sensor

SAVE CANCEL

2 | STEP FOUR: SAVE, UPLOAD AND SHARE VEHICLE CONFIGURATIONS

- Tap the Download button to save the configuration file (e.g., for trucks and trailers).

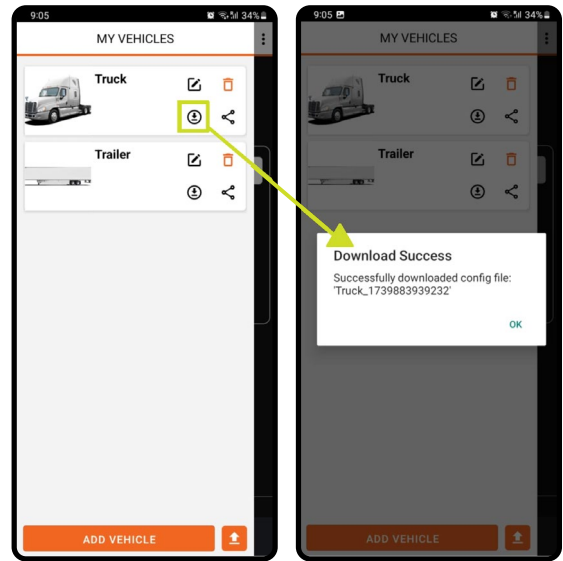

- Tap the Upload button to load a downloaded configuration file from the "Download files for both Android and iOS."

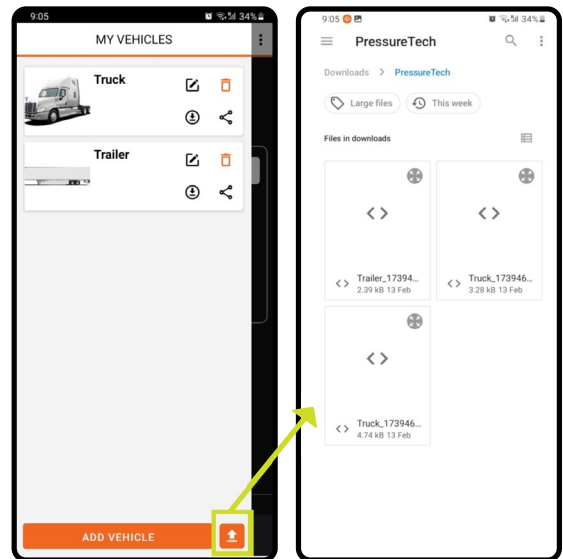

- Tap the Share button to send Vehicle Profile configuration; select preferred method of sharing.

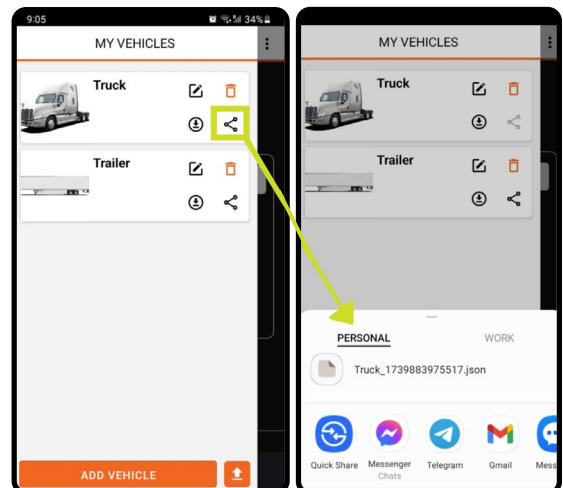

2 | **STEP FIVE: DRIVE AND MONITOR**

Once PressureTech™ sensors are configured, the “Drive Mode” page can be used to easily monitor system condition with green-yellow-red status. Green = good to drive. Yellow = monitor and check next stop. Red = pull over and inspect.

- Tap the steering wheel icon on the bottom of the screen.
- This page will display boxes for tire pressure, temperature, battery life and vehicle weight. Based on your settings, any alerts will appear on your device’s screen as yellow or red.
- Touching any status box will take you to the corresponding alert section and provide more information.
- Estimated Gross Weight, Load and Remaining Load are also displayed.

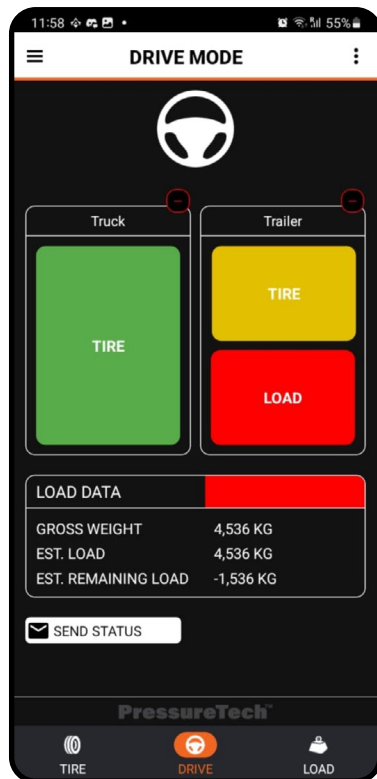
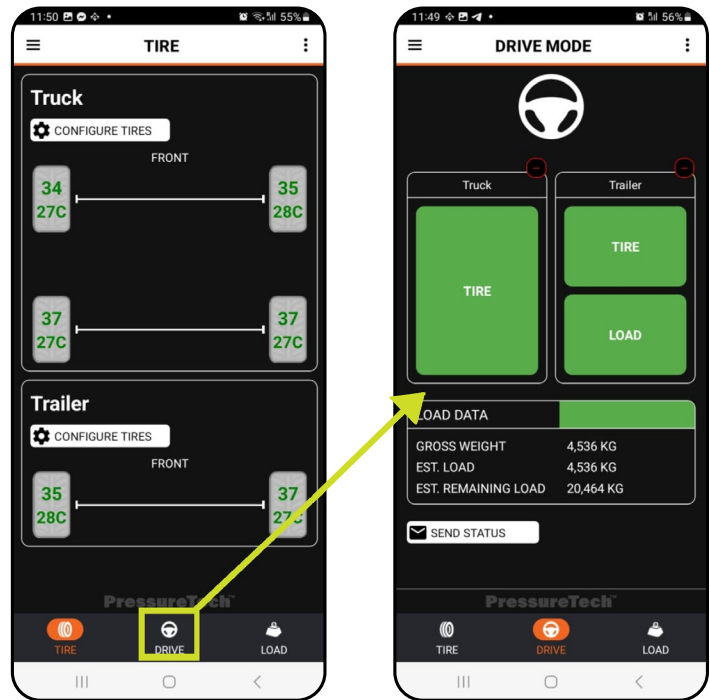

Example:

- Tire Pressure Low pressure shows red. Sensor missing or over temp shows yellow box.
- Sensor Battery Status alerts yellow if depleted.
- Overload shows red box alert.

3 | PressureTech™ TPMS

Each PressureTech™ Sensor Kit comes equipped with everything needed to complete installation, including Bluetooth valve stem sensors, anti-theft locknuts and wrench.

STEP ONE: TPMS SETTINGS

TPMS settings are defined per vehicle, allowing each vehicle to have custom alerts.

In the left side, under your vehicle name, tap the Configure tires button and change:

- Low and High Pressure warning thresholds.
- Battery % Warning level.
- Thermal Overheat Warning.

Once complete, tap Save button

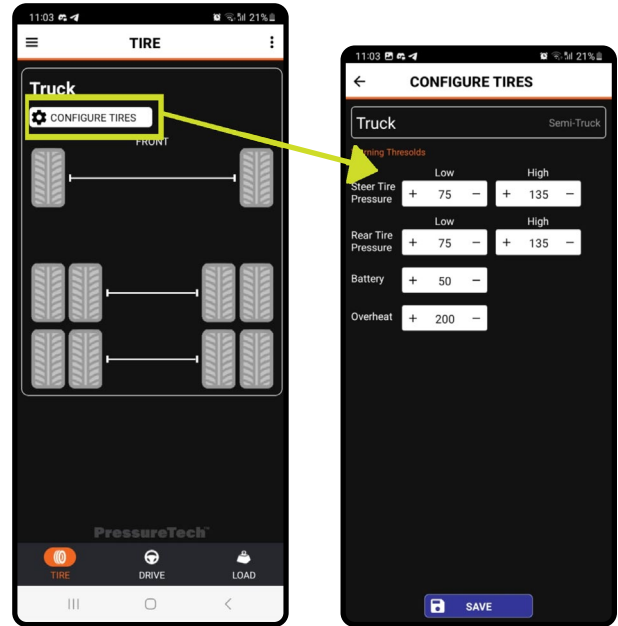

WARNINGS

Yellow flash slow when tire pressure too high.

Yellow flash slow when temperature too high.

Red battery icon when state of charge is low.

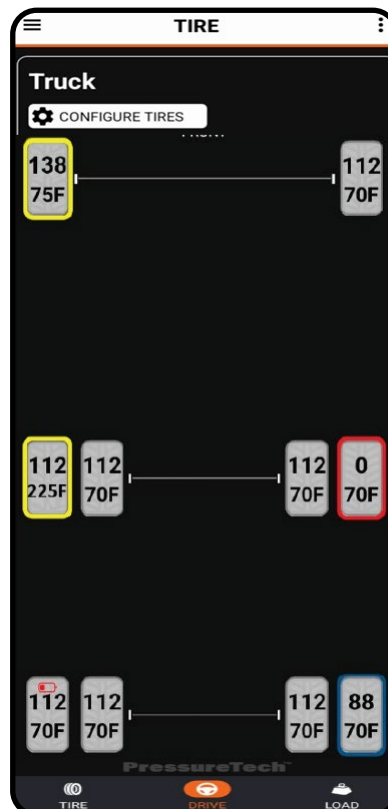

Red flash fast when warning tire pressure too low.

Blue flash slow when sensor packet is missing.

3 | STEP TWO: INSTALL TPMS

To ensure a safe and effective installation of your TPMS sensors, please follow these safety precautions:

- Always wear personal protective equipment, such as safety gloves and glasses, to prevent accidental injuries.
- Conduct the installation in a stable environment, avoiding high-traffic areas to minimize potential hazards.
- Before installation, ensure the vehicle is on a flat, stable surface with the engine off and the parking brake engaged to prevent any unintended movement.
- Before attaching sensors, make sure each valve stem is clean. If necessary, use a brush to gently clean valve stems, being careful not to damage the stem. When installing, attach the sensor securely to the valve stem.

From the Drive Mode page, select your vehicle profile. Select the TPMS page by tapping on the Tire icon located on the lower left of the screen.

- Pair the TPMS sensor to the app, access the TPMS page and tap the corresponding tire display. Tap "Add" on the pop-up window.
- Use your device's camera to scan the QR code located on top of the sensor. Once the sensor code is captured, you will see a value in the ID line of the pop-up box.
- Tap "Save."

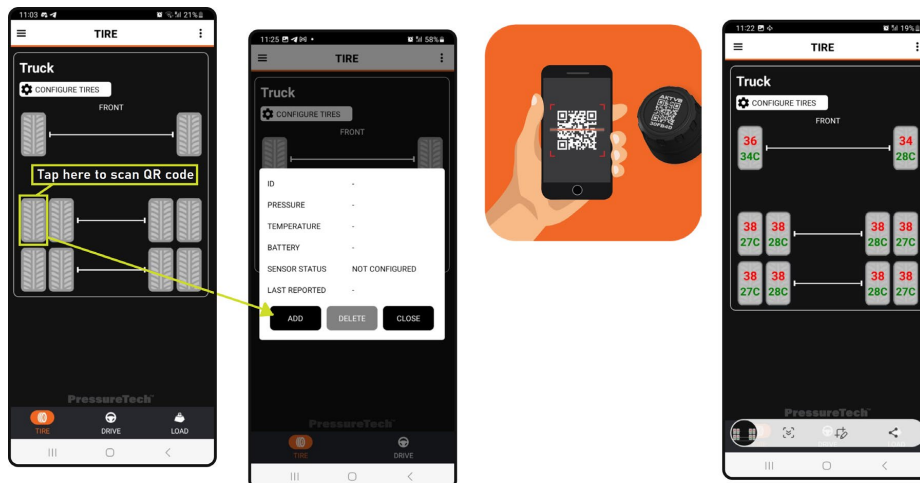

- Install the sensor on the tire stem.
 - » Thread locknut on tire stem.
 - » Thread TPMS on tire stem until finger tight.
 - » Use wrench to lock TPMS in place with locknut ~ 10 in-lbs.
 - » Check for leaks using soapy water. If bubbles appear, remove and reinstall the sensor to ensure a proper seal.
- Once configured, TPMS pressure, temperature and battery State of Charge will be displayed on each tire.

3 | PressureTech™ TPMS for Automatic Tire Inflation System (ATIS)

If your trailer is equipped with an Automatic Tire Inflation System (ATIS), and the tire hoses are not equipped with check ports, the hoses will need to be replaced with integral check port hoses to accommodate the PressureTech™ TPMS Sensors.

If you don't have a check port, contact the manufacturer of your ATIS system to see if they have one available. Or you can use the [PressureTech™ TPMS flow through sensor](#) connected directly to the valve stem.

****When using the TPMS flow through sensor, install the sensor to the valve stem first and then install the ATIS hose. Follow the instructions from your ATIS system for removing and installing the hoses. When installing flow-thru sensors on an ATIS hose, check for leaks using soapy water. If bubbles appear, remove and reinstall the sensor to ensure a proper seal.***



4 | PressureTech™ Load

Onboard Scale Sensor(s) Installation

This section details the steps for installing an Onboard Scale sensor and fitting to the air suspension system. Before you start the installation process below, the vehicle profile must be complete and the sensor(s) paired in the PressureTech™ mobile app. PressureTech™ Onboard Scale sensors are purchased with either a 1/4" or 3/8" push-to-connect tee fittings (only one fitting will be needed per axle, depending on the size of air line).

The PressureTech™ app algorithm is able to estimate full vehicle weight and can accommodate both steel-spring front steer suspension and lift axles. The SPMS measures air suspension pressure and averages it over one-minute intervals to ensure accuracy. If a loading event rapid increase in pressure is detected, the update interval temporarily switches from one minute to 15 seconds for a duration of five minutes. After this period, the system will automatically revert to one-minute intervals.

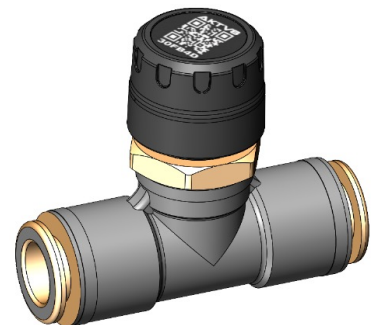

4 | Pair app to Suspension Pressure Monitor Sensor (SPMS)

- Select your vehicle from the Drive Mode window. Tap on the “Load” icon on the bottom right.
- If Steer Axle is selected in Vehicle Settings, the “Steer Settings” box will appear as shown. If steer axle suspension is air, not steel spring suspension, then see section “Steer Air Suspension.”
- If you have lift axle(s), see “Lift Axle” section below.
- To pair Load sensors, tap the eyeball icon circled orange in the picture at right.
- Use your device’s camera to scan the QR code located on top of the sensor.
- You can group the axles controlled by the same height valve, by checking the box corresponding to the “Group with Previous”
- Enter maximum weights: In “Maximum Weight” boxes, enter maximum legal weight limit for Steer, Drive, Trailer.
- Tap blue “Save” icon.

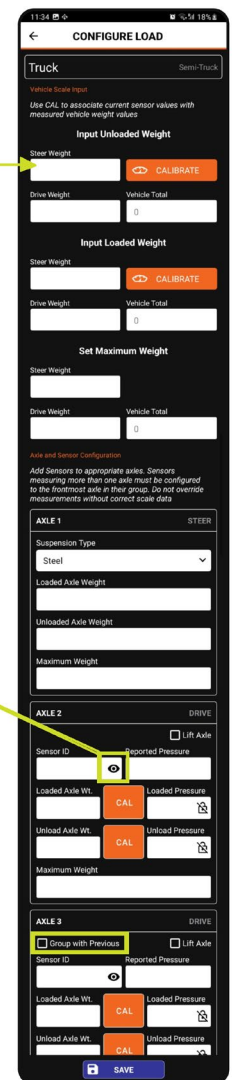
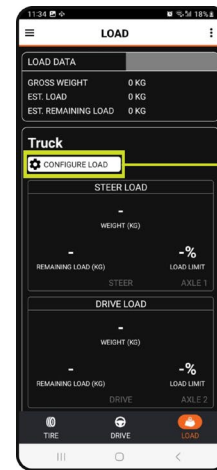
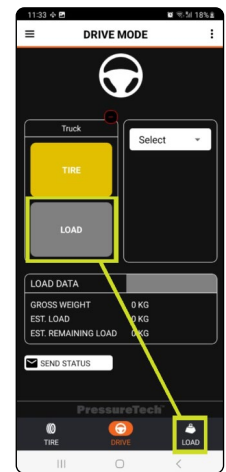

Install SPMS in Vehicle

Before onboard scale installation, make sure the vehicle is parked on a flat, stable surface. Turn off the engine, remove the key. Use the proper tools and protective equipment such as gloves, safety glasses, a creeper to go under the truck and trailer, airline cutters, rags and cleaner for the airline, and flashlight if needed.

- Apply parking brakes and chock the wheels.
- Dump the air pressure from the air suspension system.
- Find a location in the air line to install the push-to-connect tee fitting. Choose a location in the air line feeding both air springs of an axle, as close to the springs as possible (“downstream” from the leveling or dump valve).
- Select the correct tee for the air line (3/8” or 1/2”) and install a sensor on the tee valve stem by screwing on the sensor clockwise until finger tight ~10 in-lbs. **Overtightening could damage the sensor and or threads.**
- Cut air line at desired sensor location. Refer to the cutting instructions in Section 4a for details on making a proper 90-degree cut for the tee fitting installation.
- Clean the ends of the cut air line to remove any dirt or grease.
- Install tee fitting by pushing the cut ends of the air line into the ends of the tee fitting. Apply a good amount of force to ensure the air line ends go in as far as it can. Tug on the air line after installation to ensure proper engagement.

- 4 | • Start the vehicle and let the height control valve(s) charge the air system to operating pressure/height.
- Check for air leaks using soapy water and a spray bottle, refer to instruction in Section 4c. It is important that there are no air leaks in the air suspension system for the PressureTech™ system to work properly.
- Secure the air line with the sensor installed and prevent the sensor and air line from rubbing or impacting sharp edges or vehicle frame during travel.

Steer Air Suspension:

If your vehicle is equipped with front steer air suspension, an SPMS Load sensor must be paired and installed on front air spring circuit, similar to above. Tap "Suspension Type" in Steer Settings page, change to "Air," and then tap the eye icon. Follow the Load Calibration steps below, entering Unloaded and Loaded Weights and touching the orange CAL buttons.

Lift Axle:

If your vehicle is equipped with lift axle(s), an SPMS Load sensor must be paired and installed on the lift axle load spring circuit (not lift springs). Use one SPMS per lift axle control valve — if multiple lift axles controlled together by one valve, you only need one SPMS. Check the box corresponding to "Lift Axle." Follow Load Calibration steps below.

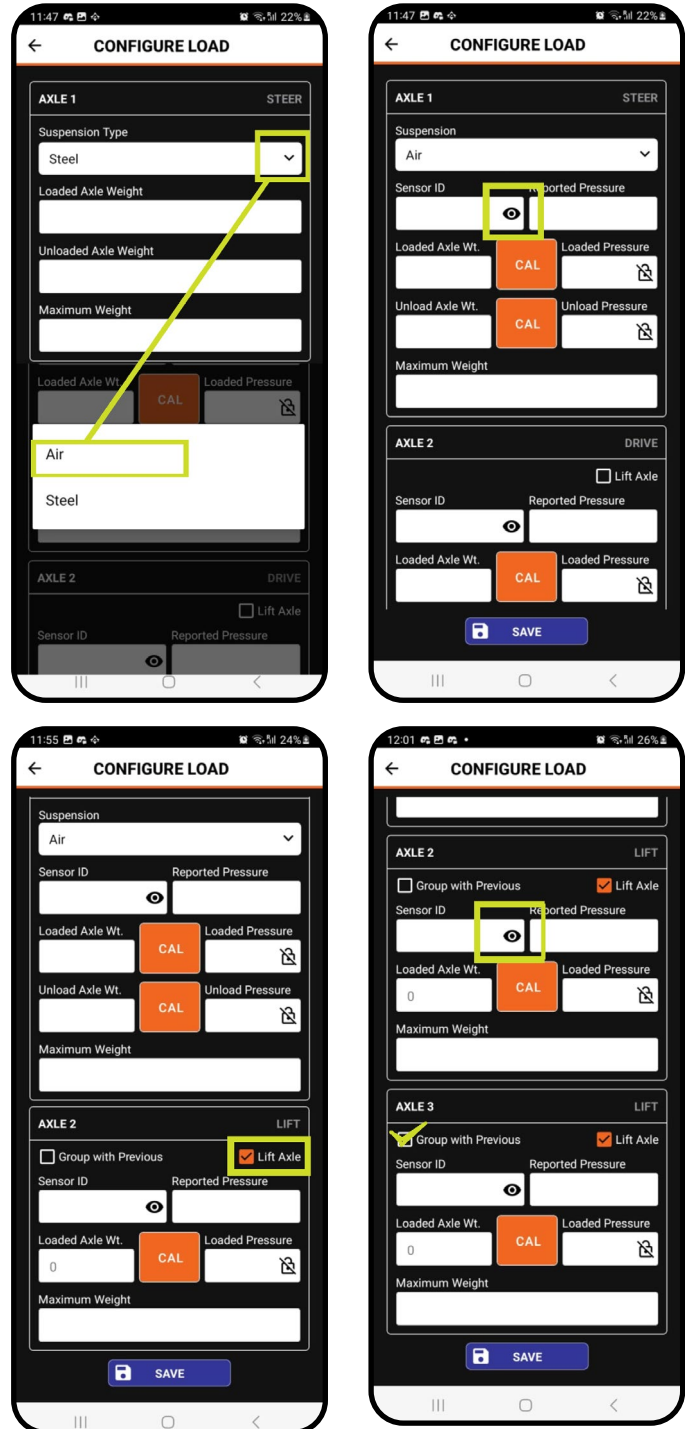

4 | Load Calibration steps:

This step requires vehicle(s) to be run over scales both unloaded and loaded. Locate certified in-ground segmented (not platform) scale station nearby and plan to travel to the scales unloaded, then load vehicles to maximum load and return to scale. See video [here](https://youtu.be/wfelG30b8hs?si=7Enez-UGJkDDv7kc) (youtu.be/wfelG30b8hs?si=7Enez-UGJkDDv7kc) for CAT scale instructions. The PressureTech™ app algorithm will estimate future vehicle weight based on these two weight inputs. If a certified in-ground segmented scale is unavailable, you can use a platform scale to measure the loaded and unloaded weights of your truck and trailer. Follow the instructions below.

Step 1: Steer + Drive



Step 2: Gross

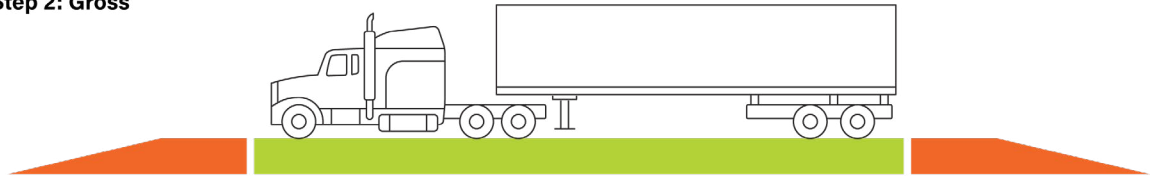

Step 3: Drive + Trailer

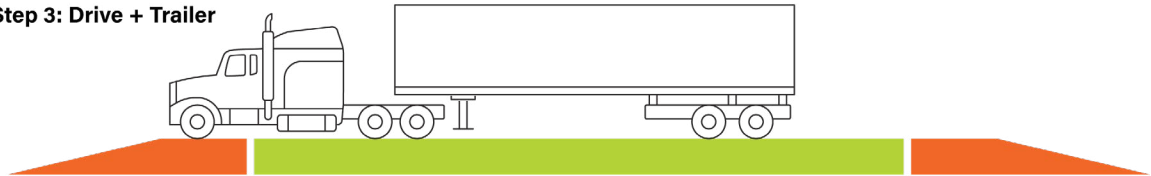

- Gross - Step 1 = Trailer Weight**
- Gross - Step 3 = Steer Weight**
- Gross - Trailer - Steer = Drive Weight**

The instructions below will guide calibration and assumes first trip to scales is with an unloaded tractor trailer.

Notes:

Failure to weigh at minimum/empty and maximum/fully loaded weights will result in inaccurate system weight estimation. Use same scale station for both unloaded and loaded scaling to maximize accuracy.

Always scale on level surface, with brakes released, and allow the vehicle to reach a steady, constant state prior to weighing. If scale station requires vehicle to be removed from scales prior to providing weight data/printout, then vehicle must be returned to a level surface with brakes released, allowing weight entry per below with vehicle in a steady/constant state.

If vehicle has lift axles, ensure they are lifted in unloaded state and deployed in loaded state.



4 | Weigh Unloaded:

Drive onto scales with your unloaded vehicle. Get the Steer Axle and Drive Axle loaded weights from the scale.

1. From the Drive Mode page, select the vehicle profiles corresponding to your truck and trailer. Tap on the "Load" icon located on the lower right.
2. Tap on the "Configure Load" button located under the name of the truck vehicle profile.
3. Enter Steer Axle and Drive Axle weights into the Input Unloaded Weight section boxes as shown on the example images.
4. Tap the Unloaded Weight "CALIBRATE" button in orange to Lock the SPMS pressure.
5. If you have not, input the allowed maximum weight for the truck on the Set Maximum Weight area.
6. Tap "Save" icon at the bottom. Go back to Load Screen and switch to trailer vehicle profile by tapping on the "Configure Load" button located under the name of the trailer vehicle profile.
7. Enter Trailer Axle weight into the Input Unloaded Weight box as shown on the example images.
8. Tap Unloaded Weight "CALIBRATE" button in orange to lock the SPMS pressure to the Unloaded Weight of the Trailer.
9. Input the allowed maximum weight for the trailer on the Set Maximum Weight area.
10. Tap "Save" icon at the bottom.

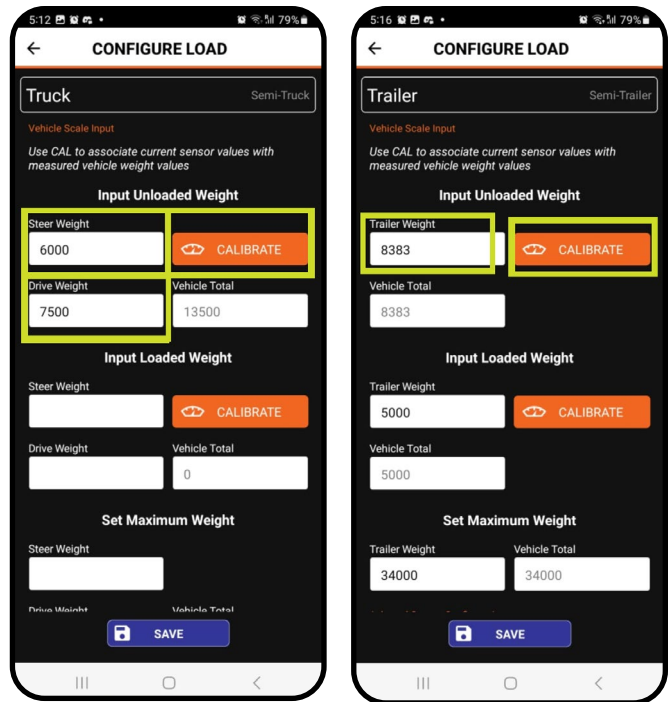

Note: You can group the axles controlled by the same height valve by checking the box corresponding to the "Group with Previous."

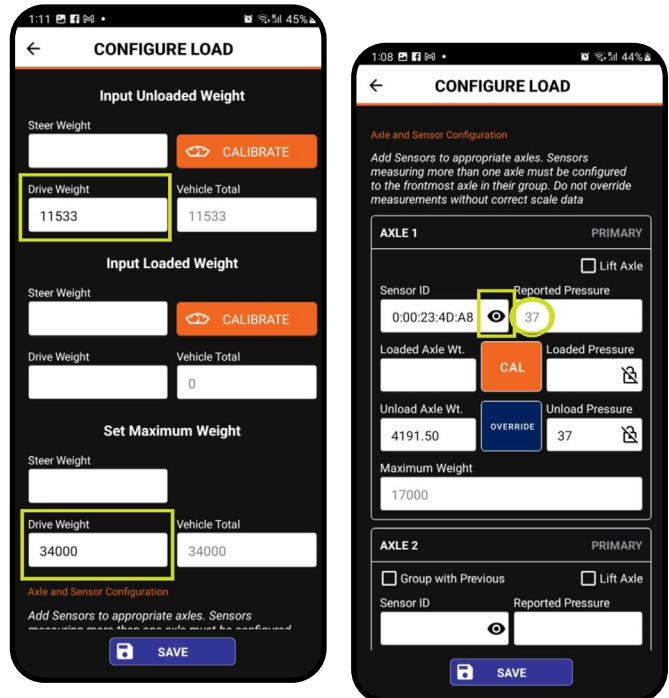

- 4 | Drive off scales and proceed to load vehicles to maximum. Return to scales and enter Loaded Weights, tap CAL and Save icon. Vehicles are calibrated!

Note: PressureTech™ automatically distributes drive and trailer weights evenly across available axles. If equipped with lift axles, the loaded weight will be distributed onto the combination of lift and drive/trailer axles. See below “Axle Override” section if per-axle calibration is required.

Axle “Override” advanced/manual calibration:

PressureTech™ includes the ability to override automatically distributed weights. For example, if user has individual axle weighing capability, it is possible to manually enter axle unloaded and loaded weights. Also, if vehicle is equipped with lift axles and user prefers to individually calibrate each lift axle set, the “override” feature can be used:

Scale axle.

1. Tap blue “Override” button — enter loaded/unloaded weights.
2. Tap orange “CAL” button.
3. Tap “Save” blue icon in top right.

Cutting Air Hose

Improper cutting of air hose is the #1 installation issue. Using the right tool the right way will ensure a leak-free connection. Using the wrong tool will cause leaks and frustration.

- ONLY use sharp-bladed tools to cut the hose square.
- DO NOT USE side cutters or scissors — these pinch the hose and create burrs that cut the internal O-rings of the push-to-connect fittings and will cause leaks.
- DO NOT cut on angle.
- We have found these to be the best tool as they have a recess for both a 1/4" and 3/8" hose. Check them out on [Amazon](#).

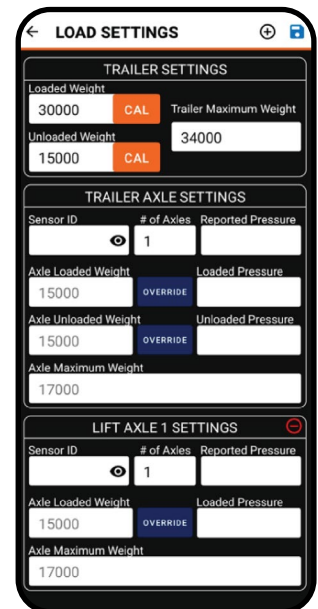
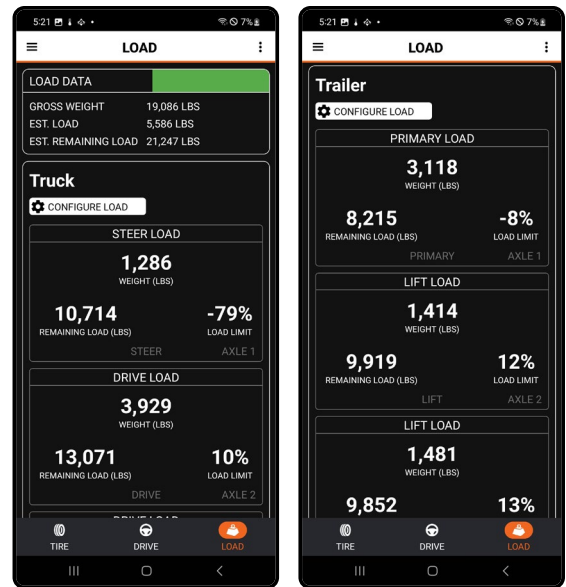

4 | Hose Insertion into Tee Fitting

- Insert nylon hose into push-in fitting.
- Push hose through collet, lightly twisting.
- Continue to push and twist hose through O-ring until tube reaches mechanical stop.
- Lightly pull hose to ensure retention: This will secure collet teeth into hose.

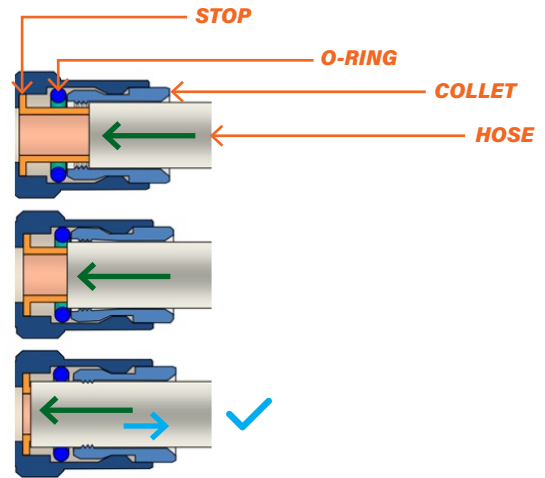

Leak Checking

- Check leaks at all connections using soapy water solution or Snoop. Soapy water in a spray bottle works great: 1 tablespoon dish detergent (no ammonia or salt) to 1 quart water, mixed.

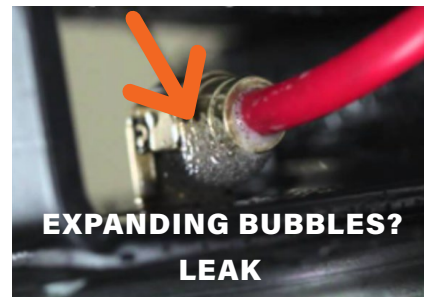
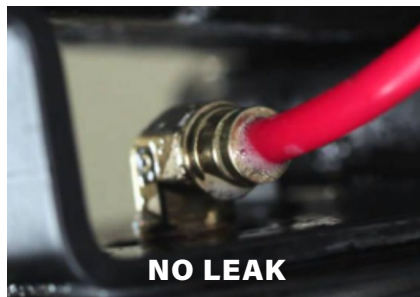

5 | Range Extender Installation

The PressureTech™ Range Extender is a rugged, waterproof ECU that can be mounted under the vehicle, preferably in a location away from rotating assemblies or heat sources. The Range Extender will automatically recognize PressureTech™ sensors and retransmit their signals via Bluetooth to your device.



The Range Extender should be installed in an equidistant/centralized between all PressureTech™ sensors and cab/cockpit to ensure optimal performance.

Before starting the installation of the Range Extender, make sure the vehicle is parked on a flat, stable surface. Engage the parking brake and use wheel chocks if necessary to prevent movement. Turn off the engine, remove the key, and disconnect the battery to avoid electrical issues. Use the proper tools and protective equipment such as gloves and safety glasses.

Range Extender Installation Instruction - RV

For RV trailers, the Range Extender unit requires a 12V (+) ignition switched and ground (-). First, determine a suitable mounting location between the PressureTech™ sensors and the cab that provides access to the 12V (+) ignition switched and ground. Ensure the chosen location is accessible and within a range of 25 feet from the furthest TPMS sensors so the range extender can communicate with the sensors and your device in the cab.

Perform a trial installation of the harness to ensure the mounting distance is adequate for the Range Extender ECU. Check if the harness needs to be extended to route comfortably without stretching or kinking.

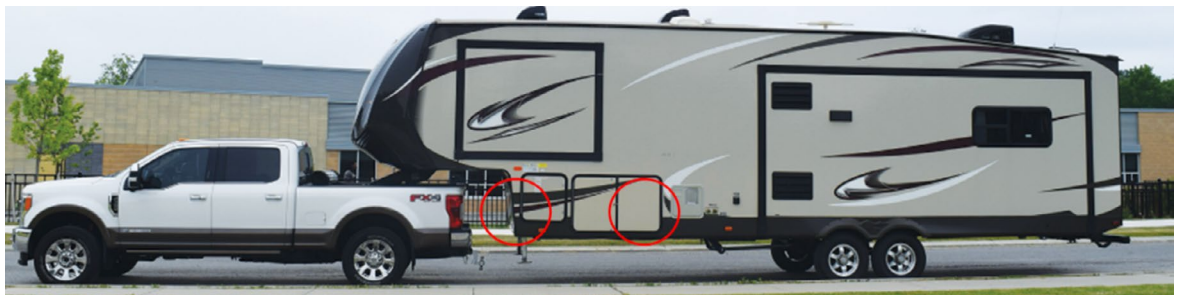

(Picture shows example locations where the Range extender could be installed.)

- 5** | Once you have confirmed the location for the Range Extender, mark the mounting hole locations. Using the provided self-tapping screws, secure the unit to the chassis. Do not exceed a maximum torque of 23 in-lbs.

The RV kit includes an inline fuse holder, along with ring terminals and butt terminals for easy installation to the battery accessory post. The installation of the inline fuse holder is optional. If you choose to install it, follow these steps:

Identify where to install the inline fuse on the red cable. Use a butt terminal to connect the inline fuse holder to the red cable, and then connect the other side of the fuse holder to a ring terminal. For the black cable, connect it directly to a ring terminal.

Finally, connect the red cable to the 12V ignition switched point (+) and the black cable to the ground point (-), ensuring secure connections.

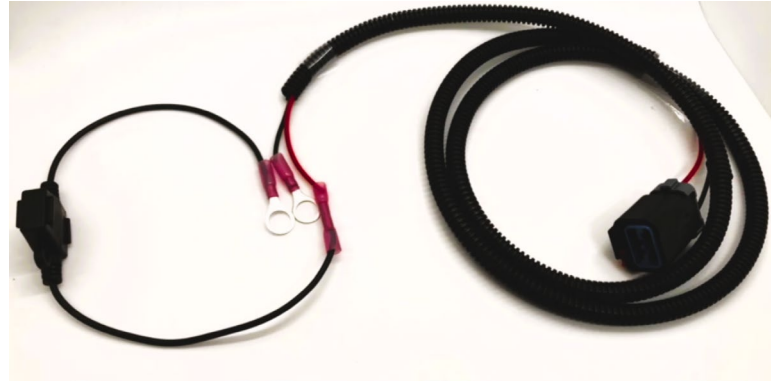

After the harness is connected to the 12V power supply and ground, insert the harness connector into the Range Extender. Once connected, secure the red lock tab as shown in the picture below.

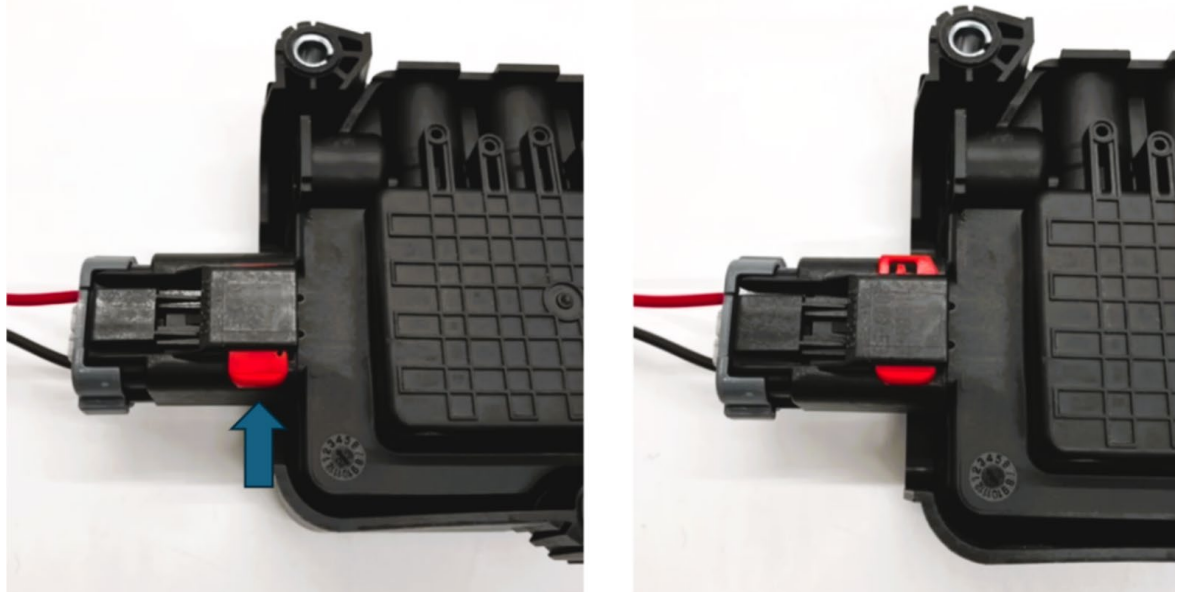

- 5 | Secure wiring while ensuring connector wiring is not strained. The wires must not be pulled to the side, as this can allow water/moisture past the wires.

Protect wiring over sharp edges/ through sheet metal holes with grommets or sheathing (split or spiral convolute works best).

Power up and confirm PressureTech™ sensors are reading from your device located in your cab.

Range Extender Installation Instruction - Commercial Vehicles

The Range Extender should be installed in an equidistant or centralized location between all PressureTech™ sensors and the cab/cockpit to ensure optimal performance.

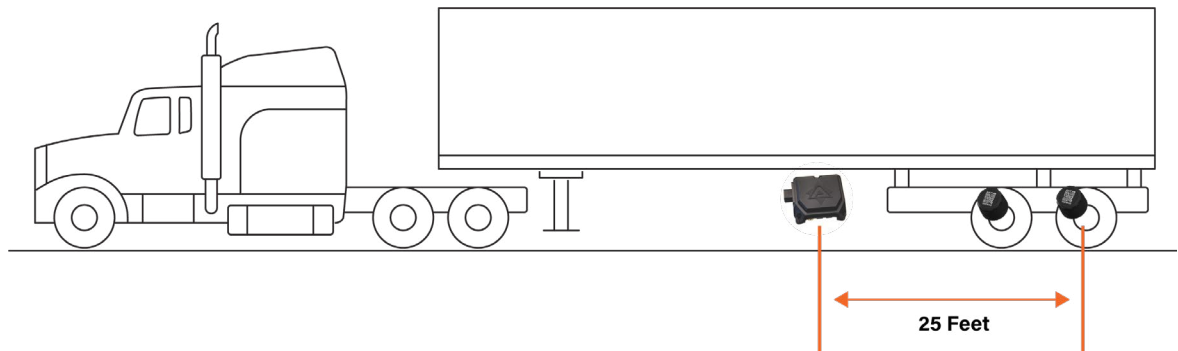

Locate the trailer’s ABS module and power cable, typically centered on the primary (non-liftable) suspension units.

Temporarily install the ABS harness jumper to determine the best distance for mounting the Range Extender manifold. Ensure the harness can be routed comfortably without stretching or kinking. Connect the ABS jumper harness (included in the kit) to the trailer ABS power cable and run the 15-foot, 3-wire Weatherpack cable as close to the front of the chassis as possible.

(Note: Connector shown on the blue circle is not used for this application.)

Connect the ABS jumper harness to the shorter harness and to the Range Extender to determine the ideal mounting location for the ECU.

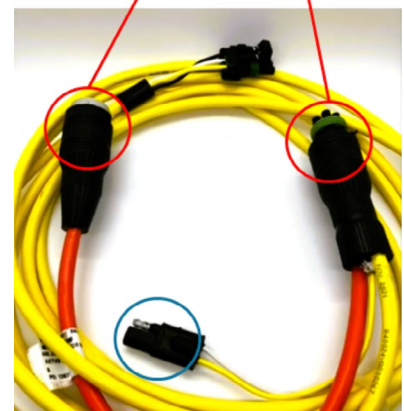
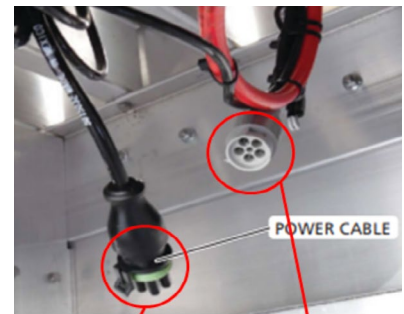
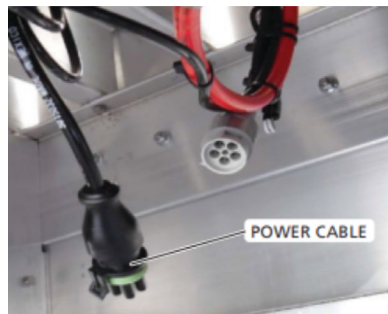

5 |

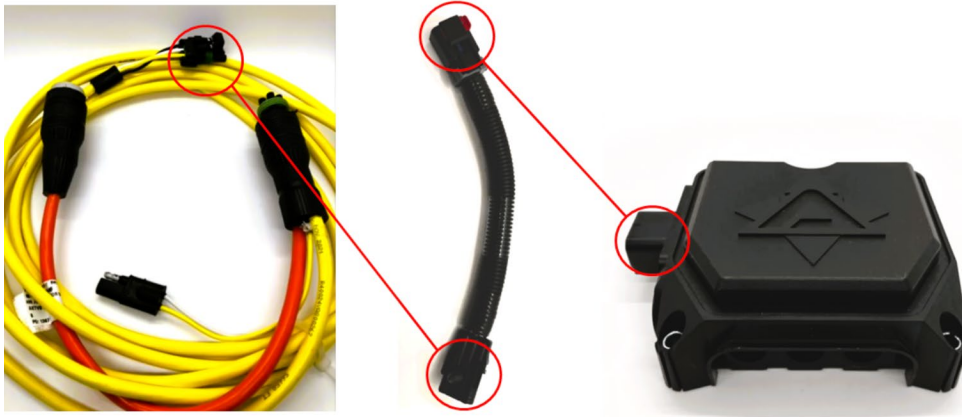

Temporarily mount the Range Extender in an open-air area (away from metal obstructions) to ensure optimal wireless communication.

Power the trailer and test the Range Extender to ensure it is operational. Using the PressureTech™ app on your tablet or phone (located in the truck cab with the doors closed), remove the farthest rear TPMS sensor and confirm the app can read it correctly.

Once you have confirmed the location for the Range Extender, mark the mounting hole positions. Using the provided self-tapping screws, secure the unit to the chassis, ensuring not to exceed a maximum torque of 23 in-lbs.

Secure the red lock tab as shown in the picture below.



Secure wiring while ensuring connector wiring is not strained. The wires must not be pulled to the side, as this can allow water/moisture past the wires.

Protect wiring over sharp edges/ through sheet metal holes with grommets or sheathing (split or spiral convolute works best).

Power up and confirm PressureTech™ sensors are reading in your cab.

6 | a. TPMS FAQ

How long does the battery life last?

The battery life for PressureTech™ Cap and Flow Thru sensors is two years.

Can the battery in the sensor be replaced? If so, how can it be done?

Yes, remove the back cover and replace as described in Section 7 of the Instruction Manual. Visit aktv8.com/guides.

If I replace the sensor battery, do I need to pair it again to the app?

No, unless you delete the sensor from the assigned tire on the app, it will remain paired to the app.

What is the range of the TPMS sensor?

The range of the TPMS sensors is approximately 30 feet. If you are planning to use the sensor beyond 30 feet from the mobile device, we recommend using our AKTV8's Range Extender.

Is the PressureTech™ app capable of saving user profiles to save sensor settings for multiple devices?

Vehicle profiles can be downloaded and shared to other devices.

What is the warranty coverage and duration?

For new PressureTech™ kits, the Limited Warranty period is one year.

For new optional add-on products sold separately, the Limited Warranty period is one year.

For repaired or refurbished items, including repaired or refurbished kits and repaired or refurbished optional add-on products sold separately; the Limited Warranty period is 90 days.

Do I need to register the product for warranty claims?

No, there is no need to register the product for warranty claims.

Where are the nearest authorized service technicians located?

Contact our AKTV8 team at support@aktv8.com for any technical assistance.

Does the sensor use O-Rings? If yes, how to replace them?

Yes, TPMS and onboard scale sensors use O-Rings, however it is not recommended to replace them.

What should I do if I lose one of the sensors? Can I buy spare sensors?

AKTV8 can sell directly to the customers, please contact us at support@aktv8.com

Are spare parts available? And where to purchase them?

Currently, there are no spare parts for sale.

6 | **Can I use the TPMS sensors on my boat trailer? Can they be submerged?**

Yes, sensors can be used on a boat trailer. The sensor is designed to meet IP67 and IP69k standards, making them water-resistant to 1 meter/3 feet. However, they are not suitable for underwater use for extended periods of time.

What is the safe tire pressure range?

Every air suspension will run at a different pressure. Most systems run between 5-150 psi. We recommend referring to the manufacturer's specifications for your specific application.

How can I clean the sensors in case they get dirty?

You can use a soft cloth or brush with a mild soap and water solution, then rinse thoroughly and dry afterward.

If I take my vehicle through a car wash with the PressureTech™ Cap or Flow Thru sensors installed, can the sensors get damaged?

No, the sensors will not get damaged, as they have been designed and tested to OEM standards. If your sensors extend outside the vertical plane of your wheel/tire assembly, there is a risk they could be grabbed by the car wash equipment. To prevent this, we recommend removing them prior to entering the car wash.

What weather temperature is suitable for the sensors to properly work?

The sensors have been tested to work within a temperature range of -40°C to 85°C (-40°F to 185°F) and should operate effectively within these conditions.

Can I use PressureTech™ Flow Thru sensors with rubber valve stems?

We recommend using the PressureTech™ Cap sensors with rubber valve stems. The Flow Thru sensors are recommended for use with metal valve systems.

Do I need to open the app every time I will drive?

No, the app works in the background, and if there is a change in pressure on the sensor, you will receive a notification on your phone or device. Just make sure to allow notifications in both the app settings and the phone settings.

Does the sensor go to sleep?

No.

How many sensors can be added on the vehicle profile?

You can have up to 34 sensors for each of your vehicle profiles.

How many sensors can the range extender handle?

The Range Extender can handle more than 50 sensors.

6 | b. Onboard Scale FAQ

How long does the battery life last?

The battery life for the PressureTech™ Onboard Scale sensors is approximately three years.

Can the battery in the Onboard Scale sensor be replaced? If so, how can it be done?

Yes, follow steps described in Section 7 of the Instruction Manual.

Visit aktv8.com/guides.

If I replace the sensor battery, would I need to pair it again to the app?

No, unless you delete the sensor from the assigned tire on the app, it will remain paired to the app.

What is the range of the Onboard Scale sensor?

The range of the Onboard Scale sensor is approximately 30 feet. If you are planning to use the sensor beyond 30 feet from the mobile device, we recommend using our Range Extender.

Is the PressureTech app capable of saving user profiles to save sensor settings for multiple devices?

Vehicle profiles can be downloaded and shared to other devices.

What is the warranty coverage and duration?

For new PressureTech™ kits, the Limited Warranty period is one year.

For new optional add-on products sold separately, the Limited Warranty period is one year.

For repaired or refurbished items, including repaired or refurbished kits and repaired or refurbished optional add-on products sold separately; the Limited Warranty period is 90 days.

Do I need to register the product for warranty claims?

No, there is no needed to register the product for warranty claims.

Where are the nearest authorized service technicians located?

You can contact AKTV8's support team at support@aktv8.com for any technical assistance.

Can I use the Onboard Scale sensor with a steel spring suspension?

Yes, the PressureTech™ app algorithm can accommodate steer axle steel springs, not on drive and trailer axles.

How many Onboard Scale sensors do I need to install on my truck?

One Onboard Scale per height control valve or lift axle.

How often do I need to re-calibrate the Onboard Scale sensor?

You only need to calibrate the Onboard Scale one time during the initial installation when pairing to the app.

6 | Can I use any type of load scale when calibrating the sensors?

It is recommended to use a segmented scale as described in the Installation Manual. It is possible to use other types of scales like a platform scale, however accuracy will be reduced. Visit aktv8.com/guides.

What is the right spot to install the load sensor?

Onboard Scale sensors can be installed anywhere in the air spring circuit between air spring and height control or dump valve. The best location is away from direct debris and water spray.

Once the fifth wheel is attached, do I need to recalibrate?

Calibrate only with truck and trailer hitched.

Does Aktv8 PressureTech Onboard Scale offers extension kits?

No, to use the Onboard Scale sensor over distances longer than 30 feet, we recommend using our Range Extender.

Do I need to open the app every time I will drive?

No, the app works in the background, and if there is a change in pressure on the sensor, you will receive a notification on your phone. Just make sure to allow notifications in both the app settings and the phone settings.

Does the sensor go to sleep?

No.

7 | a. TPMS Troubleshooting



After selecting the vehicle in the app, the screen just got stuck on white screen.

1. Close the app and reopen it.
2. Check for app software update.
3. Restart your mobile device.
4. Uninstall and reinstall the app.

App crashing/not opening.

Clear the app cache.

IOS:

1. Open the Safari app  on your iPhone.
2. Tap , tap , then tap Clear.
3. Below Clear Timeframe, choose how much of your browsing history to clear.
Note: If you have Safari profiles set up, select a profile to clear only the history of that profile, or select All Profiles.
4. Tap Clear History.

Android:

1. Go to Settings.
2. Select "Apps."
3. Choose the app.
4. Go to Storage.
5. Tap "Clear Cache."

7 | Camera is not working to scan the QR code.

1. Enter the 6-digit code under the QR code and click Save.

Pressure keeps on dropping but no leak detected.

1. Check the tire for leaks, stop the vehicle and take it in for service.
2. Check to make sure the low-pressure value is set correctly in the app to report the drop in pressure.
3. Make sure that the sensor is connected to the valve correctly.
4. Swap the sensor to isolate the issue.

Pressure reading not correct.

1. Unscrew the sensor from the valve.
2. Verify the tire pressure using a tire pressure gage and compare it to the app value.
3. If the value from the gage and the app are different, remove the battery and put it back.
4. Check if the sensor is broadcasting the correct PSI value.
5. Do a new app reset.
6. Uninstall and reinstall the app.

Sensor is not detected.

1. Turn Bluetooth on and off.
2. On the advance settings of the app, turn Scan on and off.
3. Try putting the sensor on and off pressure if the sensor still isn't broadcasting.
4. Remove the battery and put it back in the sensor.

The app is not reading the tire pressure.

1. Restart the app.
2. Restart the mobile device.
3. Uninstall and reinstall the app. Make sure to download the profile before uninstalling the app.
 - a. Save your vehicle profile by clicking on the icon as shown on the image below.

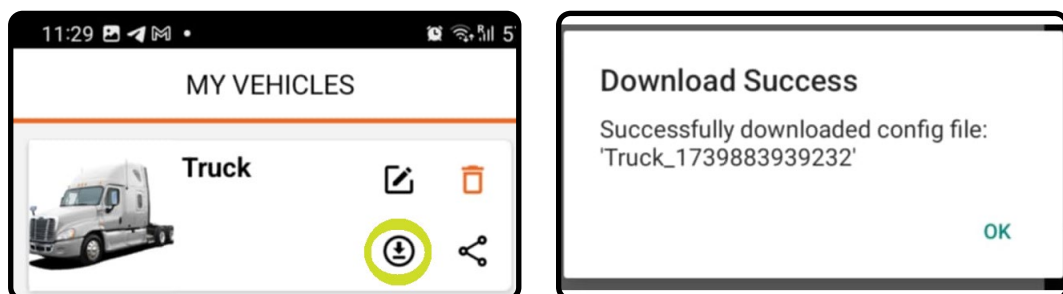

A confirmation message will pop-up.

- 7 | b. Save it to your local save file on your device.

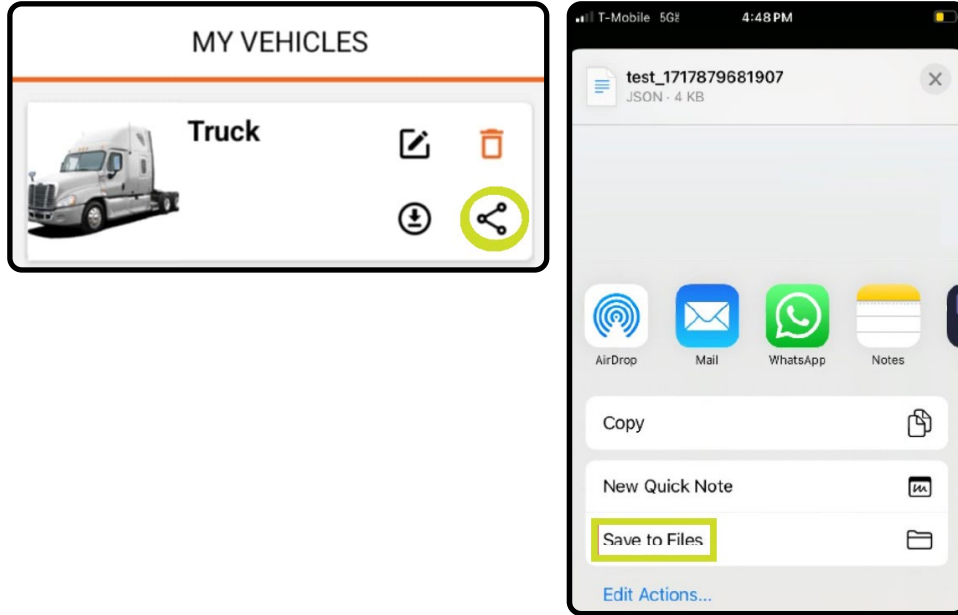

- c. Once you saved your vehicle profile, delete the app from the phone and download it again from the app store.
 d. Once you install the app on the phone, upload your vehicle profile, by selecting the icon shown on the image below.

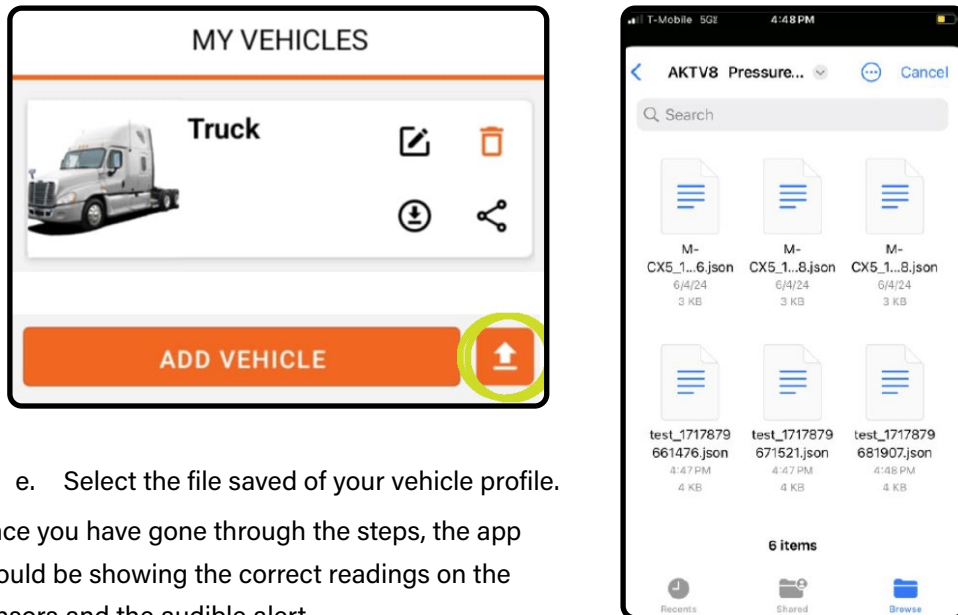

- e. Select the file saved of your vehicle profile.

Once you have gone through the steps, the app should be showing the correct readings on the sensors and the audible alert.

7 | No audible alerts.

1. Make sure the device is NOT in silent mode.
2. Make sure the device is NOT in airplane mode.
3. Set the app notification to allow sound and vibration:

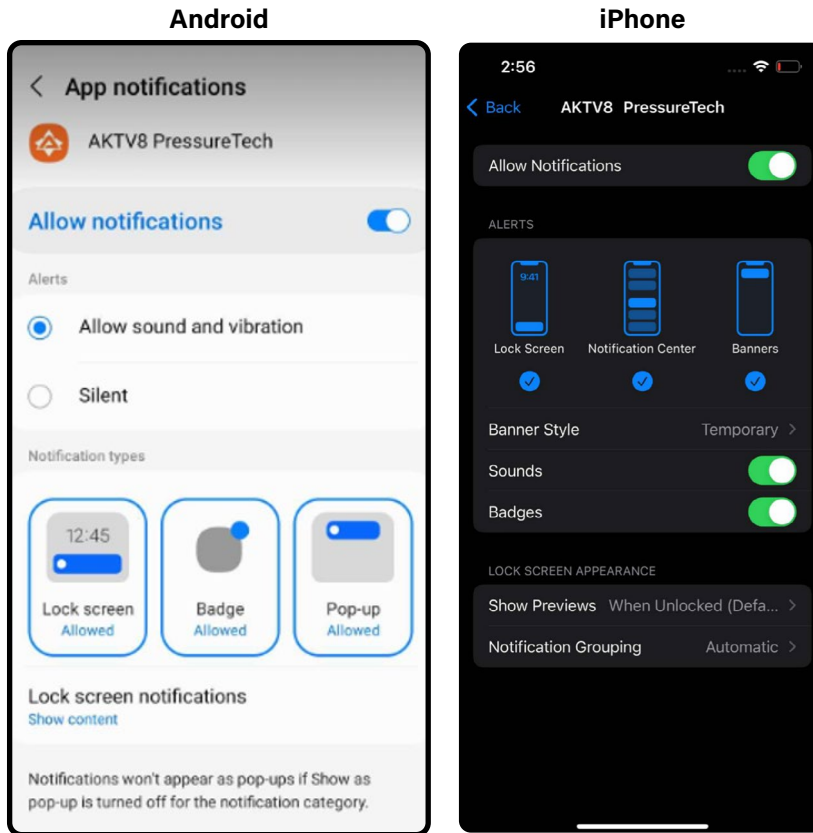

Blue band around tire/load icon

- Turn on and off notifications on the PressureTech™ app and the device settings.



Device too far from sensors.

- Move device closer to sensor location (a repeater is recommended).
- Unscrew sensor from valve stem and reinstall, ensuring Shrader valve engaged by sensor.
- All sensors will not update at identical times but should report in 30-60 seconds, depending on device.

7 | Battery below operating voltage.

- Replace battery with new 1632 lithium cell.
- Unpair the sensor from the vehicle profile on the PressureTech™ app.
- Go to the advance settings and turn Scan off and on.
- Pair the sensor back on the vehicle profile.
- NOTE: Having multiple devices connected over Bluetooth can cause connectivity issues.

If the steps above did not clear the blue band around the tire, please follow the steps below:

1. User adds a sensor to the app and vehicle.
2. User removes the sensor from the app and the valve stem off the vehicle.
3. When the sensor is added back, it reports the last known PSI value and does not update back to zero PSI.

The configuration might not be updating correctly when the user adds and removes sensors from the app. The only way to resolve this issue is by uninstalling the app completely and reinstalling, or attempting to do a full app reset.

If the issue continues, uninstall and reinstall the app.

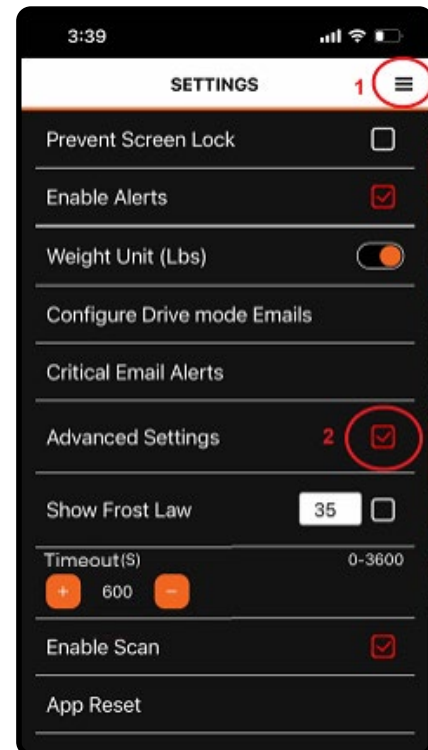

7 | b. Onboard Scale Troubleshooting



After selecting the vehicle in the app, the screen just got stuck on white screen.

1. Close the app and reopen it.
2. Check for app software update.
3. Restart your mobile device.
4. Uninstall and reinstall the app.

App crashing/not opening.

Clear the app cache.

IOS:

1. Open the Safari app  on your iPhone.
2. Tap , tap , then tap Clear.
3. Below Clear Timeframe, choose how much of your browsing history to clear.
Note: If you have Safari profiles set up, select a profile to clear only the history of that profile, or select All Profiles.
4. Tap Clear History.

Android:

1. Open your browser.
2. Android browser: Go to Menu > More > Settings or Menu > Settings > Privacy & Security. Chrome: Go to Menu > Settings > Privacy.
3. Android browser: Tap Clear cache, Clear history, and Clear all cookie data as appropriate.

Camera is not working.

1. Restart the app.
2. Restart the device.
3. Enter the 6-digit code under the QR code.

Onboard Scale not sending information to the app.

1. Wait 60 seconds for broadcast.
2. Turn on and off scan in the settings.
3. Restart the sensor, remove the battery and put it back in. (Add the page of the manual section 7).

The reading of the app is gradually dropping or the weight keeps on changing without unloading the truck.

1. Remove the air hose and check the cut if straight, if not, cut the hose using the correct tool.
2. Reconnect the sensor.

7 | The load readings in the app keep changing while in Drive Mode.

Sensor is not showing up.

1. Restart the app.
2. Restart the device.
3. Enter the 6-digit code under the QR code and click Save.

Sensor is not awake.

- Unscrew sensor from valve stem and reinstall, ensuring Shrader valve engaged by sensor.
- All sensors will not update at identical times but should report in 30-60 seconds, depending on the device.

Battery below operating voltage.

- Replace battery with new 1632 lithium cell.

App is not saving load configurations while calibrating the sensors.

- Uninstall and reinstall the app and repeat calibrating steps.

Inaccurate Readings

The vehicle is not on a level surface.

- Park on a level flat surface/road. When a vehicle is parked on a slope or uneven surface, the weight distribution of the vehicle will change among the axle groups like increased pressure or torque to the air bag.

The park brakes are on.

- When calibrating or weighing, release the parking brakes. Pressure or torque are increased to the air bag when the park brakes are on resulting to different pressure.

Air leak in the suspension system.

- Check for any leaks in the air line system as this affect the reading.

8 | Battery Replacement

PressureTech™ by AKTV8 - TPMS Cap Sensor Battery Replacement Guide

- **Remove the sensor** by loosening the jam nut and unscrewing the sensor from the valve stem of the tire.
- **Thoroughly clean the sensor** with soap and water and dry it.
- **Open the sensor** by prying the anti-rotation key from bottom of the sensor. Using a 12mm socket or wrench, hold the brass nut while twisting the cap off.

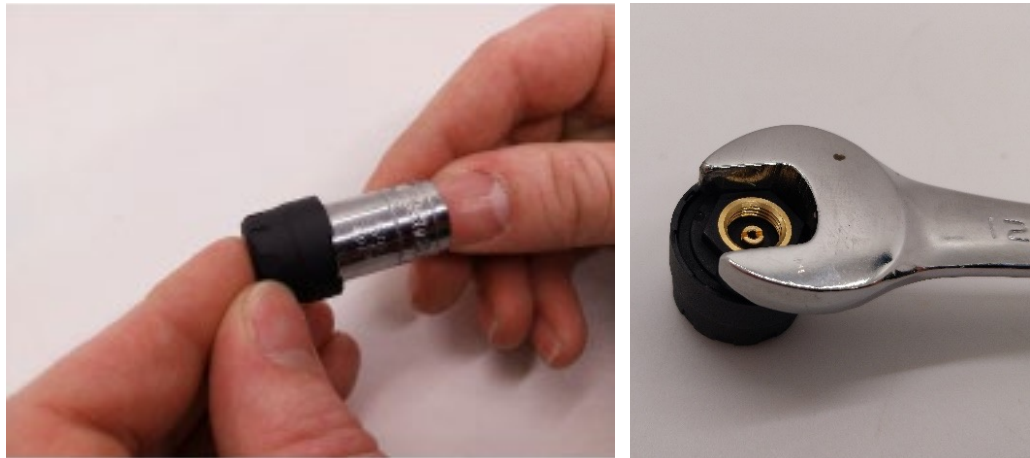
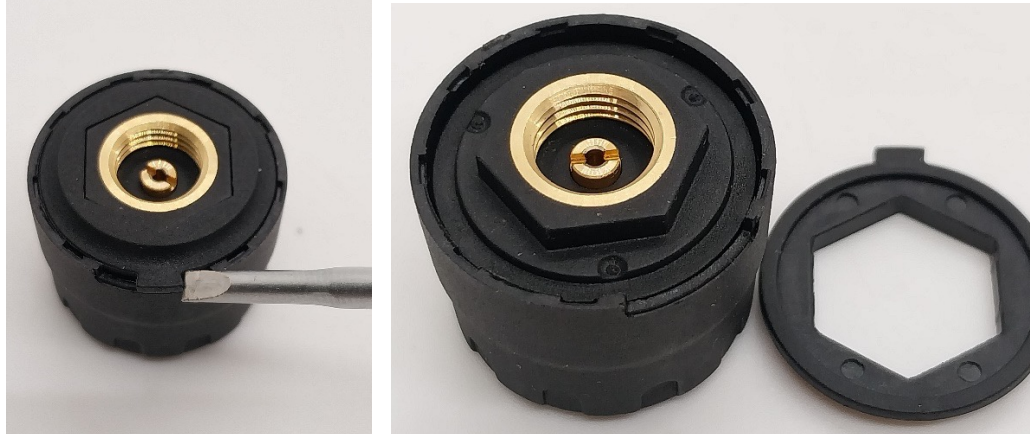

- **Locate the battery** inside the sensor.



- 8 | ▪ **Close the sensor** by gently screwing the cover back on the sensor two turns, followed by the anti-rotation key making sure the tab is correctly located in the cutout window (see image 1



below). If the key does not correctly fit in the window, (see image 2 of misaligned key) use a socket to slightly readjust the sensor in the cap until fit is achieved.



Image 1

Anti-rotation key with tab correctly located in the cutout window



Image 2

Anti-rotation key with tab misaligned in the cutout window

- **Reattach the sensor** by screwing the sensor back onto the valve stem and tightening the jam nut.
- **Confirm sensor functionality** by opening the PressureTech™ app.

8 | PressureTech™ by AKTV8 - TPMS Thru Sensor Battery Replacement Guide

- **Remove the sensor** by loosening the jam nut and unscrewing the sensor from the valve stem of the tire.
- **Thoroughly clean the sensor** with soap and water and dry it.
- **Open the sensor** by prying open the sensor using a flat-head screwdriver or similar tool.
- **Locate the battery** inside the sensor.



- **Replace the battery** by removing the old battery and inserting a new CR1632 battery. Note the battery's polarity position (+/-) so the plus (+) side is facing up.



- **Close the sensor** by gently pressing the cover back on the sensor making sure it is securely seated.
- **Reattach the sensor** by screwing the sensor back onto the valve stem and tighten the jam nut.
- **Confirm sensor functionality** by opening the PressureTech™ app.

